

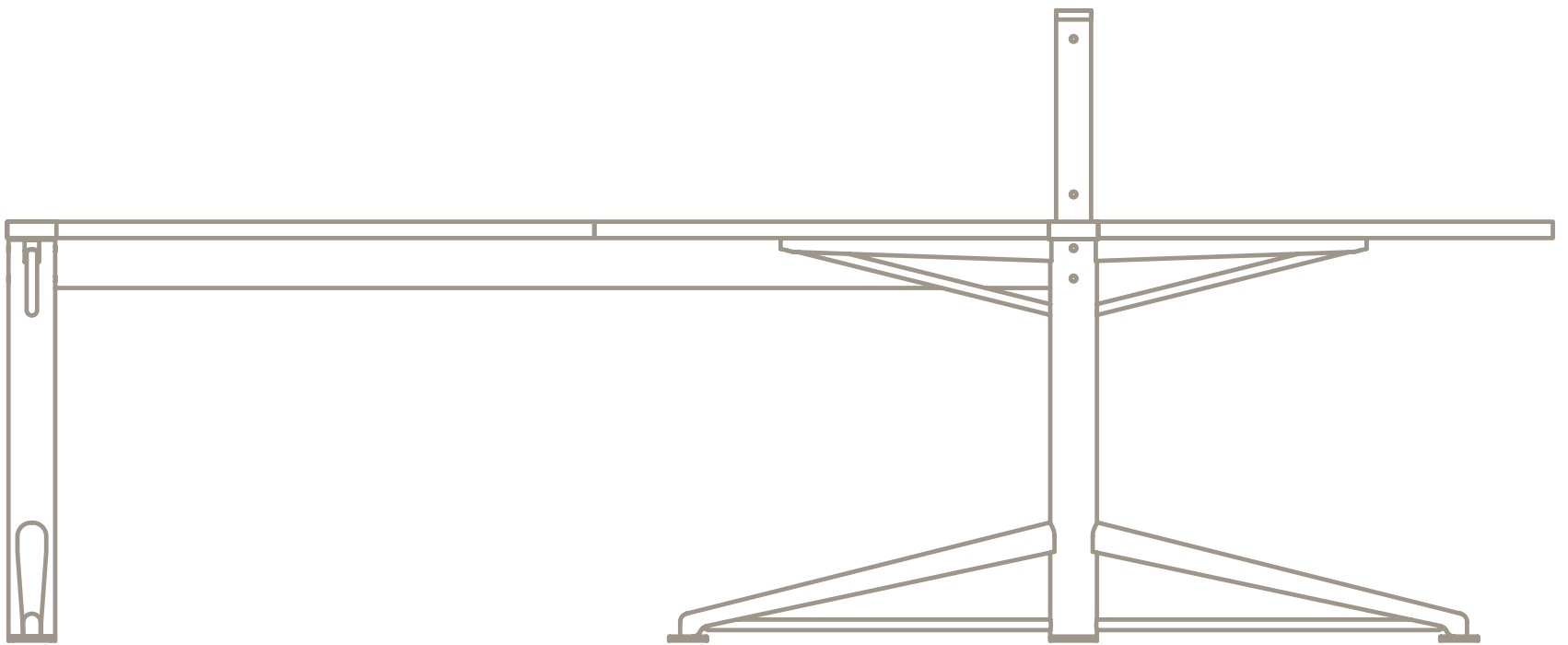

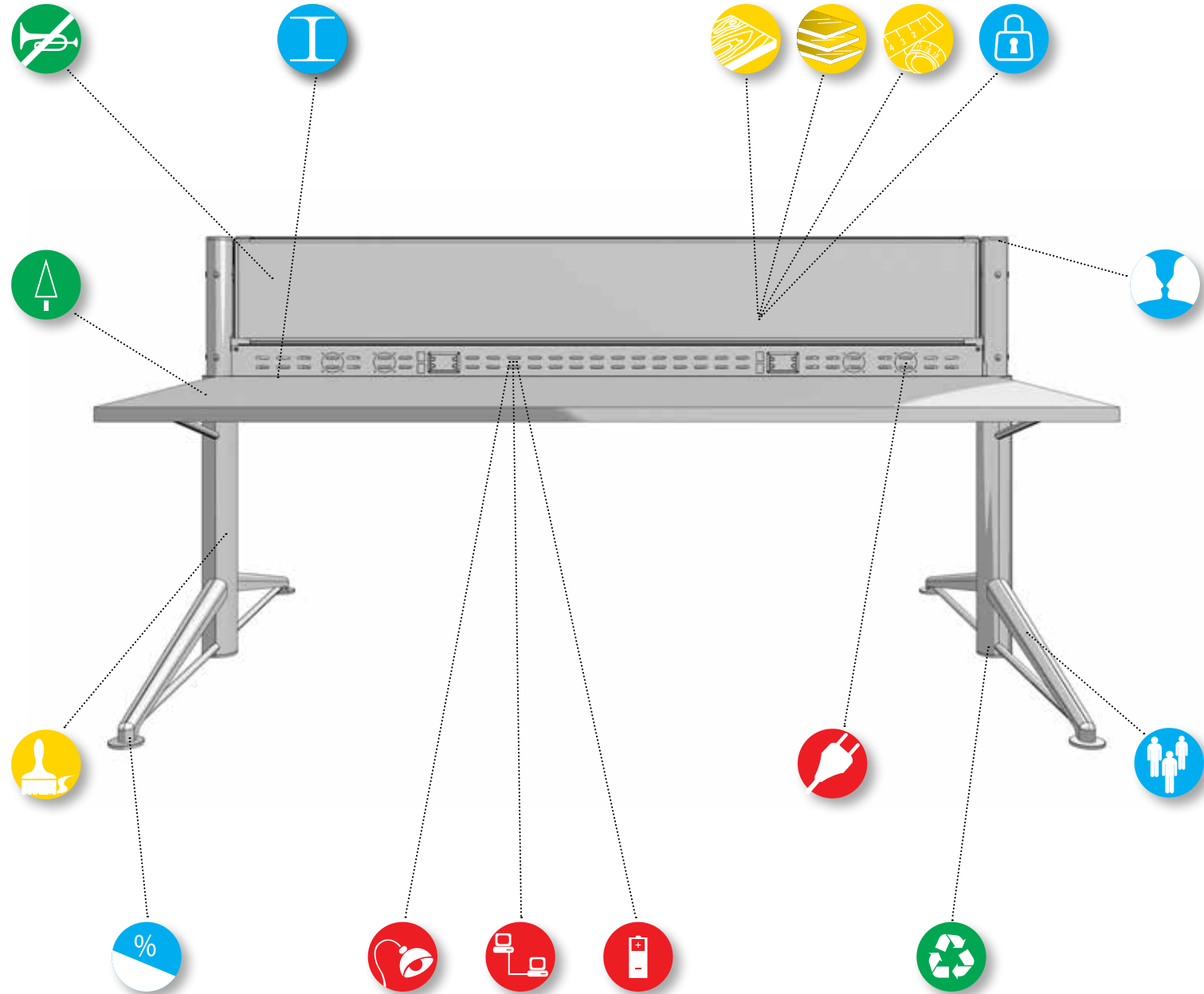



system x



Office programs







Technic

-  **trave portante in acciaio, frontale e laterale**
front and side supporting steel beam
poutre portant en acier, frontal et latéral
-  **piedi livellatori integrati**
integrated levelling feet
pieds niveleurs integres
-  **gambe intermedie per configurazioni affiancate**
shared legs for side by side desks
pied intermediaires pour bureau cote a cote
-  **gamba decentrata singola**
single decentralized leg systems for single workplace
pied decentralises systèmes de travail individuel
-  **wall screen pareti divisorie per privacy visiva e acustica**
wall screen partition walls for visual and acoustic privacy
panneaux de séparation pour privacy de visuelle et acoustique
-  **gamba doppia sistemi di lavoro condivisi**
double leg for shared workplace systems
double pieds systèmes de travail partagés

Aesthetics

-  **varietà cromatica per le parti metalliche e gli elementi in truciolare melaminico**
different colors for metal and melamine parts
différents couleurs pour les parties en metal et melamine
-  **sistema costruttivo modulare in planimetria e prospetto**
modular system in prospectus plan
construction modulaire en plan à perspective
-  **divisori frontali/laterali in legno nella stessa finitura dei piani**
wood front/side panels in the same finish of the tops
séparateurs frontal/latéraux bois dans la même finitions des plateaux
-  **divisori frontali/laterali in vetro trasparente ed acidato**
clear and etched front/side glass panels
séparateurs frontal/latéraux en verre transparent et acidifié
-  **divisori frontali/laterale in tessuto**
fabric front/side panels
séparateurs frontal/latéral en tissu

Wire management

-  **computer**
ordinateur
-  **illuminazione**
lighting
illumination
-  **rete**
network
reseau
-  **energia**
power
energie
-  **accessori per elettrificazione:**
canala metallica sottopiano
vertebra per risalita cavi
wire management:
cable beams
vertebra gone up cable
passage cables:
chemin porte cable
tresse porte cable

Environment -Eco

-  **il melaminico è realizzato con legnami riciclabili**
melamine panel 100% recyclable
panneau melamine 100% recyclable
-  **bassa emissione di formaldeide del melaminico**
low emission of formaldehyde
basse emission de formaldehyde
-  **il metallo è riciclabile**
metal is 100% recyclable
le metal est 100% recyclable
-  **contenimento rumore**
containment of noise
limitation du bruit
-  **utilizzo di energia da fonti rinnovabili mancata emissione di CO2 in atmosfera pari a 104.677 Kg e 5,44 Kg di polveri**
energy's use from renewable sources missed of issue of CO2 in atmosphere equal to 104.677 Kg and 5,44 Kg of dusts
utilise énergie de sources renouvelables manquée émission de CO2 en atmosphère même à 104.677 kg et 5,44 Kg de poussières

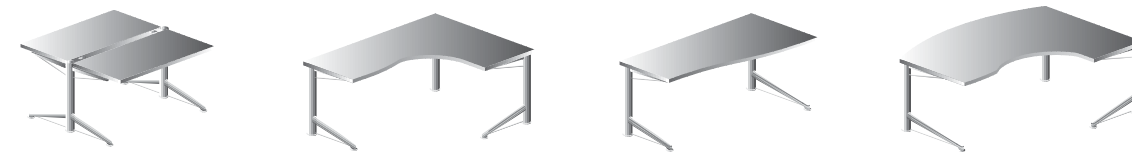

Desk

"DESK" configurazione orizzontale _ Systemx Desk, si sviluppa in orizzontale e rappresenta la soluzione ideale per uffici con un'unica postazione, può configurare aree di lavoro differenti tra loro organizzandosi in isole operative o in aree direzionali dalla singola scrivania a gruppi di lavoro più complessi.

"DESK" horizontal configuration _ SystemX Desk extends horizontally and it is the best solution for only one workstation office; a wide choice of shapes provides the opportunity for creating many types of working spaces getting organized in work islands or office furniture, from the only one desk to complex working group.

"DESK" configuration horizontale _ Systemx Desk, se développe en horizontal et représente la solution idéale pour bureaux avec un unique emplacement, peut configurer des aires de travail différentes entre en s'elles organisant en îles opérationnelles ou en aires directionnelles de l'individuel bureau à des groupes de travail plus complexe.





Scrivania DESK:

singola con piano di lavoro in melaminico grigio e struttura metallica verniciata in tinta argento. _ Table DESK: single with grey melamine worktop and metal structure painted in silver colour. _ Bureau DESK: unique avec plateau de travail en mélaminé gris et structure en métal argent.



Scrivania DESK:

con allungo laterale integrato dimensione 160x160 x80/60, piano in melaminico rovere chiaro e struttura metallica verniciata in tinta micato - antracite. _ Table DESK: with integrated lateral extension dimension 160x160x80/60, melamine top in white oak and metal structure painted in micato-anthracite colour. _ Bureau DESK: avec rallonge latéral complémentaire dimension 160x160x80/60, plateau en mélaminé Chêne clair et structure en métal micato-anthracite.



Particolare DESK:

canalina sottopiano che collega frontalmente/lateralmente le gambe portanti, si realizza in lamiera d'acciaio verniciata nella stessa tinta delle gambe. _ Particular DESK: Channel under top that connects front/side supporting legs, made of in sheet metal painted in the same colour of the legs. _ Particulier DESK: Canal sous-plateau qui réunit l'avant /coté des pieds de support, est réalisé en tôle d'acier peinte dans le même couleur des pieds.

**Scrivania DESK:**

workstation con allungo laterale aggiuntivo (80x60), si realizza uno sviluppo laterale di 240 cm, piano in melaminico rovere scuro e struttura metallica verniciata in tinta micato - antracite; la postazione viene completata con gonna frontale in melaminico rovere scuro. _ Table DESK: workstation with additional lateral extension (80x60), there is a lateral development of 240 cm, top in melamine dark oak and metallic structure painted in micato-anthracite colour, workstation is completed with frontal panel in melamine dark oak. _ Bureau DESK: workstation avec extension latéral supplémentaire (80x60), on réalise un croissence latéral de 240 cm, plateau en mélamine Chêne noir et structure métallique en mica-anthracite; le poste de travail est complété avec un panneau frontal en mélamine Chêne noir.



Scrivania DESK:

tavolo rettangolare, dimensioni 160x80, con allungo coplanare agganciabile da 120x60; il piano in melaminico noce canaletto e struttura metallica verniciata in colore bianco. Sul fondo schermi divisorio auto-portanti rivestiti in tessuto (K122) a cui si appoggia una slitta attrezzata con cuscino (in tessuto) e contenitore basso/medio; struttura bianca e componenti in legno in melaminico noce canaletto. _ Table DESK: rectangular table, dimensions 160x80, with coplanar extension dockable 120x60; top in melamine Walnut and metallic structure painted in white colour. At the end fabric self-bearing frontal panel (K122) on which leans a sledge equipped by pillow (in fabric) and cabinet low/medium); metallic structure white colour and components in melamine walnut. _ Bureau DESK: table rectangulaire, dimensions 160x80, avec extension coplanaire ancrable de 120x60, plateau en melamine noyer et structure métallique verni blanc. Derrière écrans de séparation autoporteur en tissus (K122) sur laquelle s'appuie un glissière équipé de un coussin (en tissu) et conteneur basse/moyenne; structure blanc et composants en bois en melamine noyer.

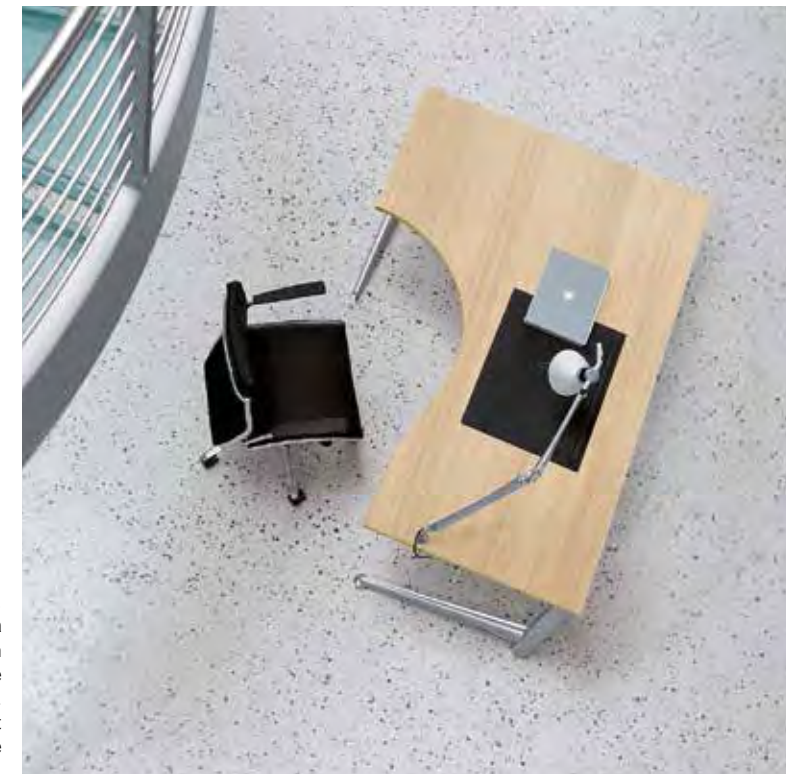

Vista DESK:

vista dall'alto della postazione di lavoro con allungo integrato destro e sinistro. La gamba d'angolo e' a colonna cilindrica semplice. Piano in melaminico finitura rovere chiaro e struttura metallica in tinta argento. _ View DESK: view from high workstation with integrated extension right and left. The corner leg is a simple cylindrical column. Top in melamine white oak and metallic structure in silver colour. _ Vue Desk: Vue d'en haut du poste de travail avec rallonge intégré droite et gauche. Le pied d'angle est a colonne cylindrique simple. Plateau en melamine Chêne clair et structure métallique en argent.



Isola multipla DESK/WALL:

postazioni di lavoro con allungo integrato sinistro. Piani in melaminico bianco e struttura metallica tinta argento. Sul fronte le postazioni sono separate da schermi rivestiti in tessuto (K98) che poggiano su un carter metallico (fuoriesce dal piano per un'altezza di 38 cm) preforato a passo costante per il posizionamento di gruppi presa dati/energia (versione WALL). _ Multiple Island DESK/WALL: workstation with integrated left extension. Tops in melamine white and metallic structure in silver colour. In front workstations are separated by fabric panels (K98) leaning on a metallic carter (it get out from the top to a height of 38 cm) pre-perforated at a constant pitch for the placing of socket data/energy (version WALL). _ Multiple île DESK/WALL: poste du travail avec rallonge intégré a gauche. Plateaux en melamine blanc et structure métallique en argent. Devant le poste de travail sont séparé avec écrans en tissu (K98) qui se appuie sur un carter en métal (déborde du plateau par un hauteur de 38 cm) pré-perçés avec un pas constant pour le positionnement des groupes prenant données/énergie.



Dettaglio e vista DESK/WALL:

punto di aggancio alla gamba del tubo reggi-schermo. Vista dall'alto di postazioni disposte parallelamente. Piano di lavoro in melaminico noce canaletto e struttura metallica in tinta argento. Lo schermo frontale e' rivestito in tessuto rosso (K104). _ View detail DESK/WALL: point of attachment to the leg and tube screen-holding. View from high of parallel workstation. Work top in melamine Walnut and metallic structure in silver colour. Frontal panel is in red fabric (K104). _ Détail et vue DESK/WALL: point de fixation au pied du tube écran de rétention. Vue d'en haut des postes de travail disposés parallèlement. Plateau de travail en melamine noyer et structure métallique en argent. Panneau frontal en tissu rouge (K104).



Dettaglio DESK/WALL:

particolare della canalizzazione laterale, coplanare al piano, predisposta di tappi plastici utili alla fuoriuscita delle utenze dati e rete che in essa transitano. _ Detail DESK/WALL: particular of lateral channel, coplanar to the top and prepared by plastic plugs for the exit of cable. _ Détail DESK/WALL: particulier du canalisation latéral, coplanaire au plateau, avec bouchon en plastique utile à la fuite des utilisateurs de données et réseau qui passe à travers elle.



Wall

"Wall" lo spazio evolutivo: Systemx Wall nasce dall'esigenza di condividere uno spazio operativo favorendo il movimento e la comunicazione tra operatori rispettandone la privacy. Infatti, grazie all'utilizzo di pannelli divisorii disponibili in tre altezze, ciascuno può sviluppare mansioni diversificate in assoluta autonomia. I pannelli divisorii, rivestiti in tessuto nelle svariate combinazioni colore, vengono corredati da utili accessori posizionati lungo una guida in metallo, servendo al meglio l'operatore. Systemx dual segue l'evoluzione di un mondo del lavoro che cambia rapidamente assetti e posizioni senza interferire con la struttura architettonica che lo ospita. Systemx dual, si sviluppa in orizzontale e verticale configurando gruppi di lavoro operativi, zone direzionali o call center.

"Wall" evolving space _ SystemX Wall borns from the demand to share an operative space, encouraging the movement and the operators' communication, respecting the privacy. With three different heights dividing walls, every operator may works in absolute autonomy. The dividing walls covered in many different fireproof fabric colours are available with some complementary items. SystemX Dual follows the work world evolution, which changes endlessly without troubling the architectonic structure around. SystemX Dual extends horizontally and vertically shaped workstation groups, directional areas or call centres.

"Wall" l'espace évolutif _ Systemx Wall naît de l'exigence de partager un espace opérationnel en favorisant le mouvement et la communication entre des opérateurs en respectant le privacy. En effet, avec l'utilise de panneaux mitoyens disponibles en trois hauteurs chacun peut développer des fonctions diversifiées en absolue autonomie. Les panneaux mitoyens, revêtus dans tissu dans variées combinaisons couleur, sont accompagnés de profits accessoires des long une guide en métal, en servant au mieux l'opérateur. Systemx dual suit l'évolution d'un monde du travail qui change rapidement des organisations et les positions sans interférer avec la structure architecturale qui le reçoit. Systemx dual, se développe en horizontal et vertical en configurant des groupes de travail opérationnels, des zones directionnelles ou call centre.





Composizione

a due posti di lavoro con piani sagomati in melaminico rovere chiaro, struttura metallica tinta argento, pannelli di elevazione con rivestimento in tessuto e vetro. Dimensioni 320x160. _ Two light oak finish shaped workstations, structure metal silver color, panels for rising covered in fireproof fabric and glass. Dimensions 320x160. _ Composition à deux places de travail avec des plans façonnés en mélamine chêne clair, structure en métal couleur argent, panneaux d'élévation avec revêtement dans tissu et verre. Dimensions 320x160.



Dettaglio WALL:

particolare della canalizzazione frontale preforata per prese dati e rete, lateralmente la canalizzazione, coplanare al piano per la fuoriuscita dei cavi di servizio. Frontale in tessuto nero (K98) con sopra luce in vetro trasparente. Piani in rovere chiaro e strutture in tinta argento. _ Detail of WALL: particular of frontal channel –pre-perforated for data and network cable, in the side channel coplanar to the top for the cable exit. Frontal in black fabric (K98) with over light in transparent glass. Top in white oak and metallic structure in silver colour. _ Détail WALL: Particulier du canalisation frontal pré-perçés pour prenant données et énergie, latéralement la canalisation, coplanaire avec le plateau de la sortie de cables de service. Panneau frontal en tissu noir (K98) avec sur-lumiere en verre transparent. Plateaux en Chêne clair et structure en teinte argent.



**Composizione WALL:**

Systemx Wall a quattro posti di lavoro, piani sagomati in melaminico grigio chiaro, struttura grigio metallizzato, pannelli di elevazione rivestiti in tessuto H 180 (K103). Struttura metallica doppia condivisa. Dimensioni: 320x320. _ Four grey finish shaped workstations, structure metal grey finish, panels for rising covered in fireproof fabric H 180 (K103). Double metallic structure shared. Dimensions 320x320. _ Composition Systemx Wall à quatre places de travail, plans façonnés en mélamine gris clair, structure gris métallisé, panneaux d'élévation revêtus dans tissu H 180 (K103). Ajouter structure métallique double partage. Dimensions: 320x320.



Composizione WALL:

struttura metallica doppia condivisa. Composizione a quadrifoglio con piani in melaminico bianco e strutture metalliche tinta argento. La canalizzazione frontale fuori piano e' attrezzato con prese dati e rete. _ Composizione WALL: double metallic structure shared. Composition cloverleaf with white melamine top and silver metal structure, Frontal channel over the top is equipped with data and network cable. _ Composizione WALL: structure métallique double partage. Composition en trèfle avec melamine blanc et structure métallique argent. La canalisation frontal hors du plan est équipée avec prenant données et énergie.



Dettaglio WALL:

particolare della canalina con prese frontali fuori piano. Si realizza in lamiera d'acciaio appositamente perforata a passo costante. _ Detail WALL: particular of chanel with frontal socket over the top. Made of in perforated sheet steel with a constant pitch. _ Détail WALL: Particulier du canal avec prenants frontal hors du plan. On se réalise en tôle d'acier pré-perçés avec un pas constant.





Isola multipla WALL:

struttura metallica a gamba doppia condivisa. Piani di lavoro in melaminico noce canaletto, struttura in finitura bianca e schermi frontali in tessuto verde (K109). _ Multiple Island WALL: metallic structure with double leg shared. Work top in melamine Walnut, White structure and fabric frontal panel in green (K109). _ Multiple île WALL: structure métallique avec double pied commun. Plateau de travail en melamine noyer, structure blanc et écrans frontal en tissu vert (K109).

Finiture

FINISHES

Finiture Finishes

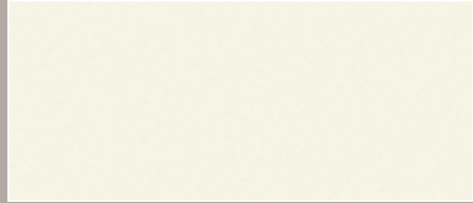

T01 bianco
white



T02 grigio
grey



T19 pero
pear

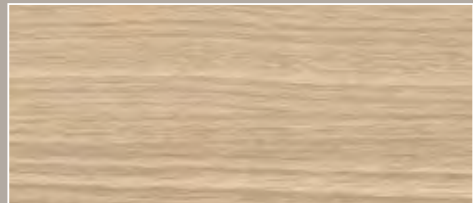

T32 rovere
white oak

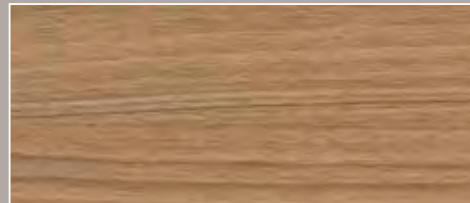

T40 noce canaletto
walnut

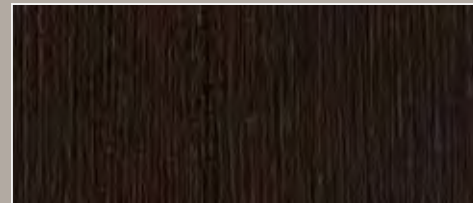

T42 rovere scuro
dark oak

Strutture metalliche

Metal structures / Structures métalliques

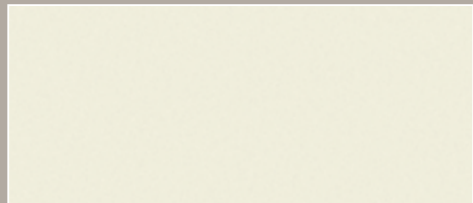

V01 bianco
white / blanc

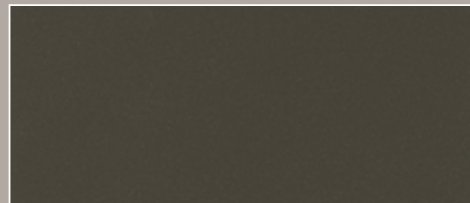

V05 antracite micato
mica anthracite

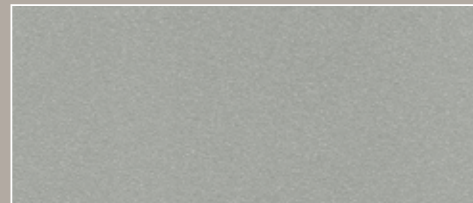

V73 argento
silver / argent

Vetri

Glass / Verre

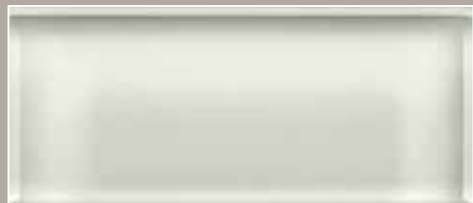

Trasparente
transparent



Acidato
frosted

Gamma colori

COLOUR RANGE

Tessuti ignifughi classe 1

Class 1 fireproof fabrics / Tissus ignifuges de classe 1



K98



K100



K101



K102



K103



K104



K105



K106



K107



K108



K109



K120



K122

Pannelli in melaminico

Melamine panels colours / Panneaux en mélaminés

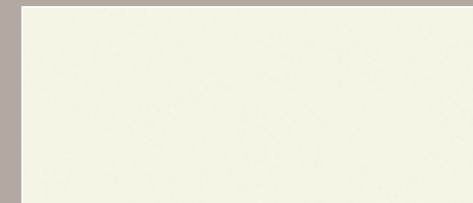

T01 bianco
white / blanc

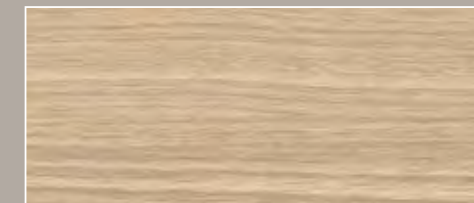

T32 rovere
white oak / chêne clair

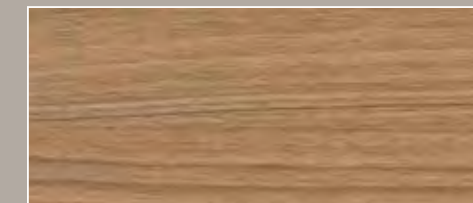

T40 noce canaletto
walnut / noyer

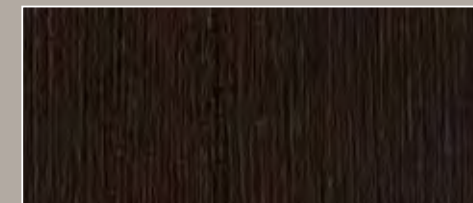

T42 rovere scuro
dark oak / chêne noir

Informazioni tecniche

TECHNICAL INFO / INFORMATIONS TECHNIQUES

Desk

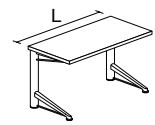

L. 80 / 100 / 120 / 140 / 160 / 180
P. 60
H. 72

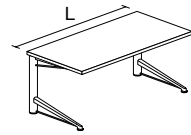

L. 80 / 100 / 120 / 140 / 160 / 180
P. 80
H. 72

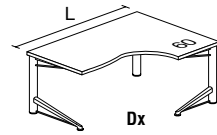

L. 160 / 180
P. 120
H. 72

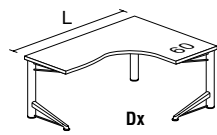

L. 160 / 180
P. 120
H. 72

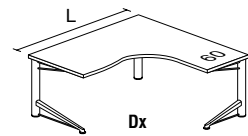

L. 160
P. 120
H. 72

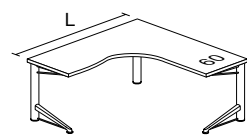

L. 160
P. 120
H. 72

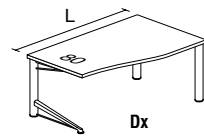

L. 160 / 180
P. 100
H. 72

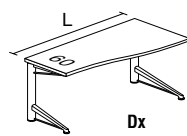

L. 160 / 180
P. 80
H. 72

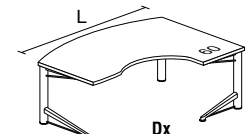

L. 160 / 180
P. 140
H. 72

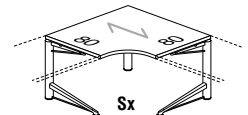

L. 120
P. 120
H. 72

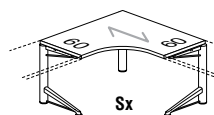

L. 120
P. 120
H. 72

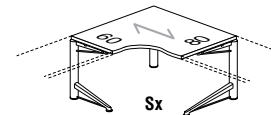

L. 120
P. 120
H. 72

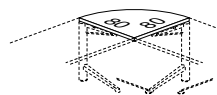

L. 80
P. 80

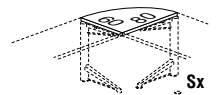

L. 80
P. 60

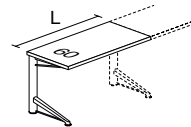

L. 80 / 100 / 120 / 140 / 160 / 180
P. 60
H. 72

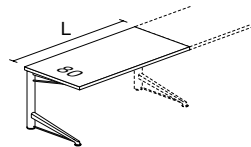

L. 80 / 100 / 120 / 140 / 160 / 180
P. 80
H. 72

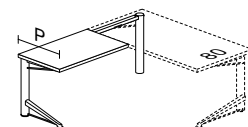

L. 100
P. 60 - 80
H. 72

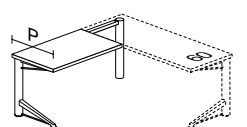

L. 100
P. 60 - 80
H. 72

Wall

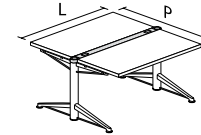

L. 100 / 120 / 160 / 180
P. 132,2
H. 72

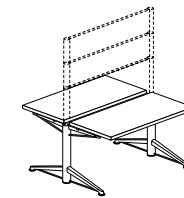

L. 100 / 120 / 160 / 180
P. 132,2
H. 72

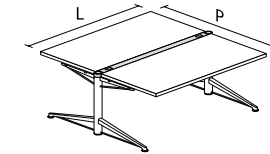

L. 100 / 120 / 160 / 180
P. 172,8
H. 72

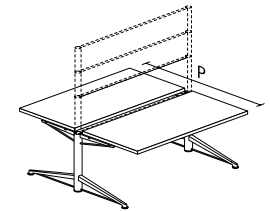

L. 100 / 120 / 160 / 180
P. 172,8
H. 72

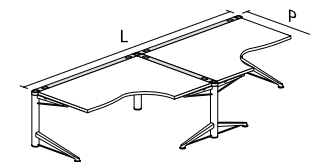

L. 320 / 360
P. 120
H. 72

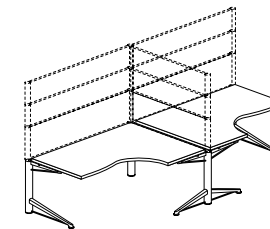

L. 320 / 360
P. 120
H. 72

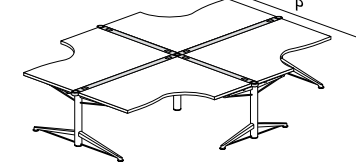

L. 320 / 360
P. 240
H. 72

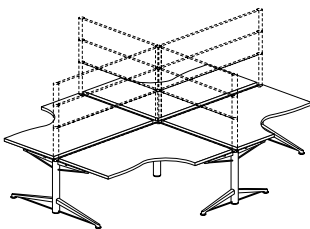

L. 320 / 360
P. 240
H. 72

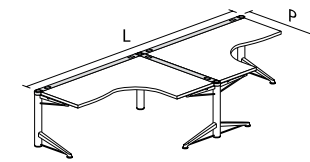

L. 320 / 360
P. 120
H. 72

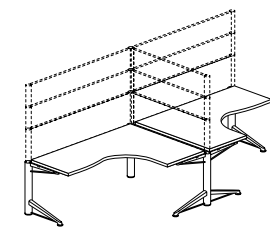

L. 320 / 360
P. 120
H. 72

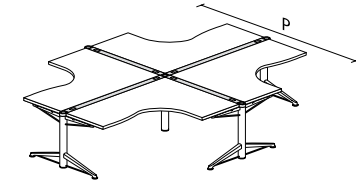

L. 320 / 360
P. 240
H. 72

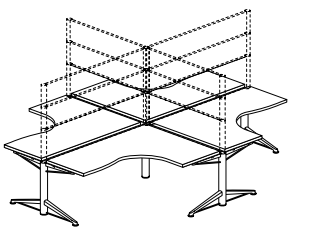

L. 320 / 360
P. 240
H. 72

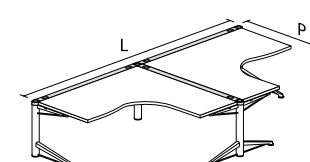

L. 320
P. 160
H. 72

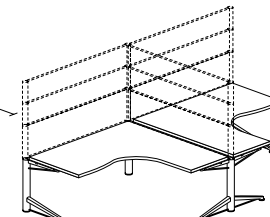

L. 320
P. 160
H. 72

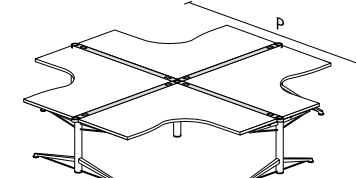

L. 320
P. 320
H. 72

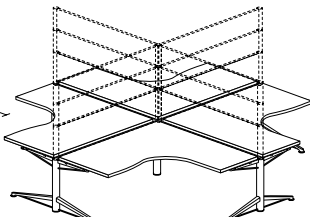

L. 320
P. 320
H. 72

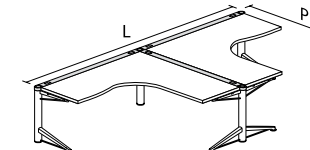

L. 320
P. 160
H. 72

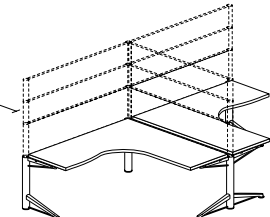

L. 320
P. 160
H. 72

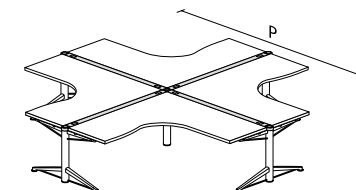

L. 320
P. 320
H. 72

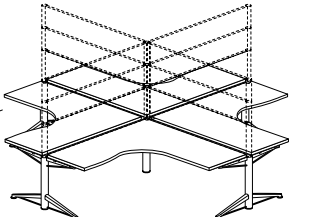

L. 320
P. 320
H. 72

Informazioni tecniche

TECHNICAL INFO / INFORMATIONS TECHNIQUES

Wall

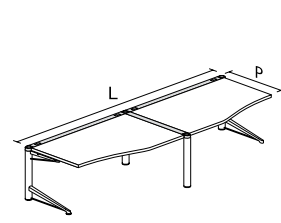

L. 320 / 360
P. 100
H. 72

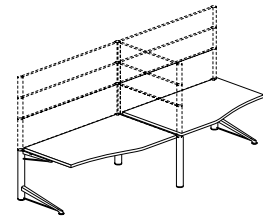

L. 320 / 360
P. 100
H. 72

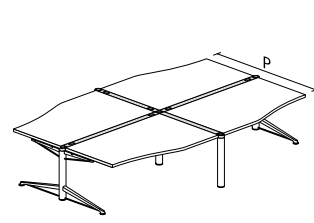

L. 320 / 360
P. 200
H. 72

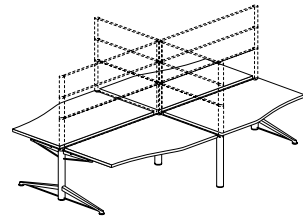

L. 320 / 360
P. 200
H. 72

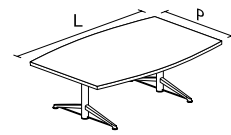

L. 200 - 240
P. 125
H. 72

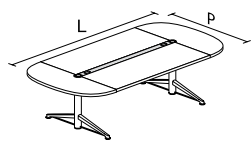

L. 260 / 280
P. 126,4
H. 72

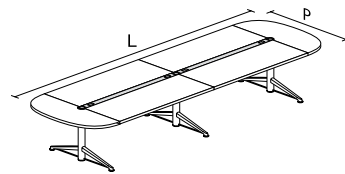

L. 420 / 460 / 580 / 740
P. 126,4
H. 72

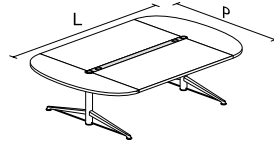

L. 260 / 280
P. 166,4
H. 72

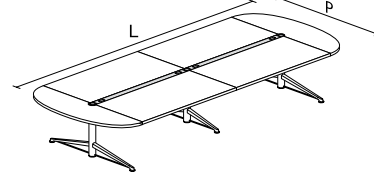

L. 420 / 460 / 580 / 740
P. 166,4
H. 72

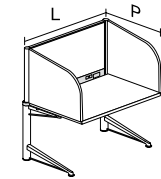

L. 100 / 120
P. 60 / 80
H. 140

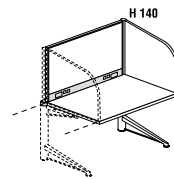

L. 100 / 120
P. 60 / 80
H. 140

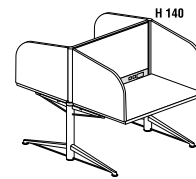

L. 100 / 120
P. 120 / 160
H. 140

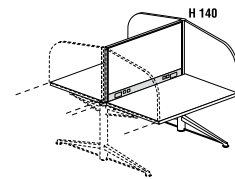

L. 100 / 120
P. 120 / 160
H. 140

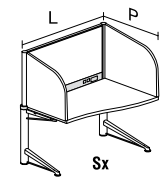

L. 120
P. 60/80
H. 140

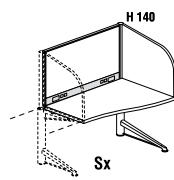

L. 120
P. 60/80
H. 140

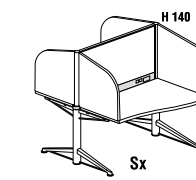

L. 120
P. 120/160
H. 140

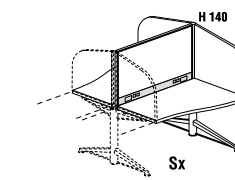

L. 120
P. 120/160
H. 140

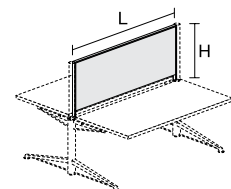

L. 100 / 120 / 160 / 180
P. 4
H. 24,7 / 54,7 / 94,7

Caratteristiche tecniche

TECHNICAL CHARACTERISTICS / CARACTÉRISTIQUES TECHNICIEN



Staffa sottopiano rinforzata.
Over top reinforced bracket.
Support dessous-plan renforcée.



Piede a terra della gamba singola.
Foot on ground for the single leg.
Pied à terre du jambe single.

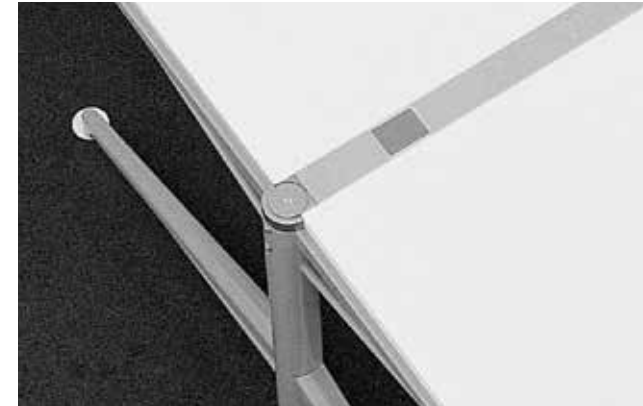

Canalizzazione coplanare al piano (gamba doppia).
Coplanar channel to the top (double leg).
Canalisation coplanaire au plateau (pied double).

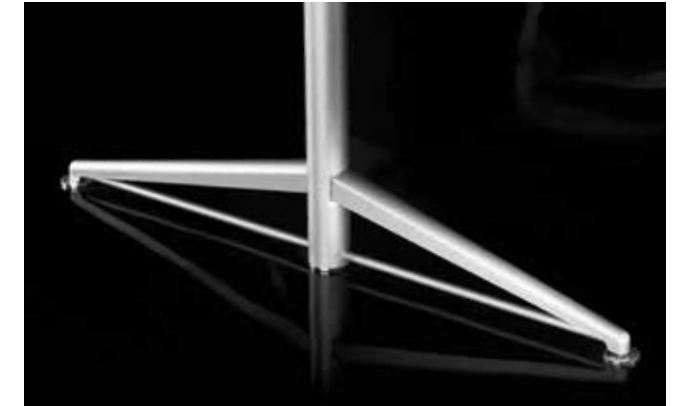

Staffe al piede di contatto a terra (gamba doppia).
Brackets at the contact foot at ground (double leg).
Support pour le pied de contact à terre.



Canalizzazione coplanare al piano (gamba singola).
Coplanar channel to the top (single leg).
Canalisation coplanaire au plateau (pied single).



Trave longitudinale sottopiano.
Longitudinal beam under top.
Travers longitudinal dessous-plan.



Prese dati ed energia su canalina frontale.
Data and power sockets on the frontal channel.
Données et prises de courant sur le canal frontal.



Fuoriuscita cavi dati ed energia.
Exit data and power cable.
Sorti données et câbles électriques.



Gamba a colonna in posizione intermedia.
Column leg in intermediate position.
Pied au colonne en position intermédiaire.



Giunto di contatto tra gamba e schermo verticale.
Contact joint from leg top vertical screen.
Joint de contact entre le pied et l'écran vertical.

Progetti

PROJECTS / PROJETS

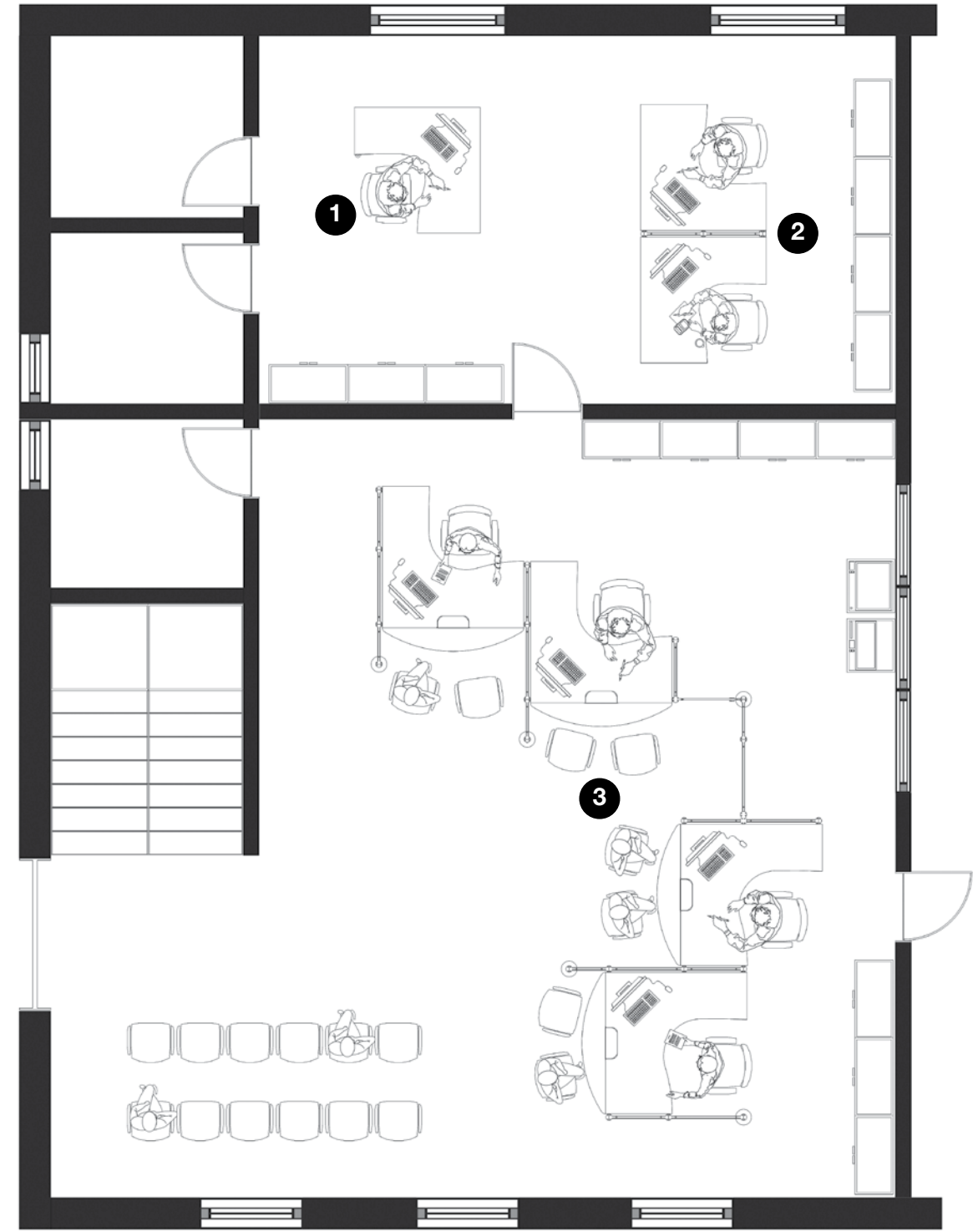
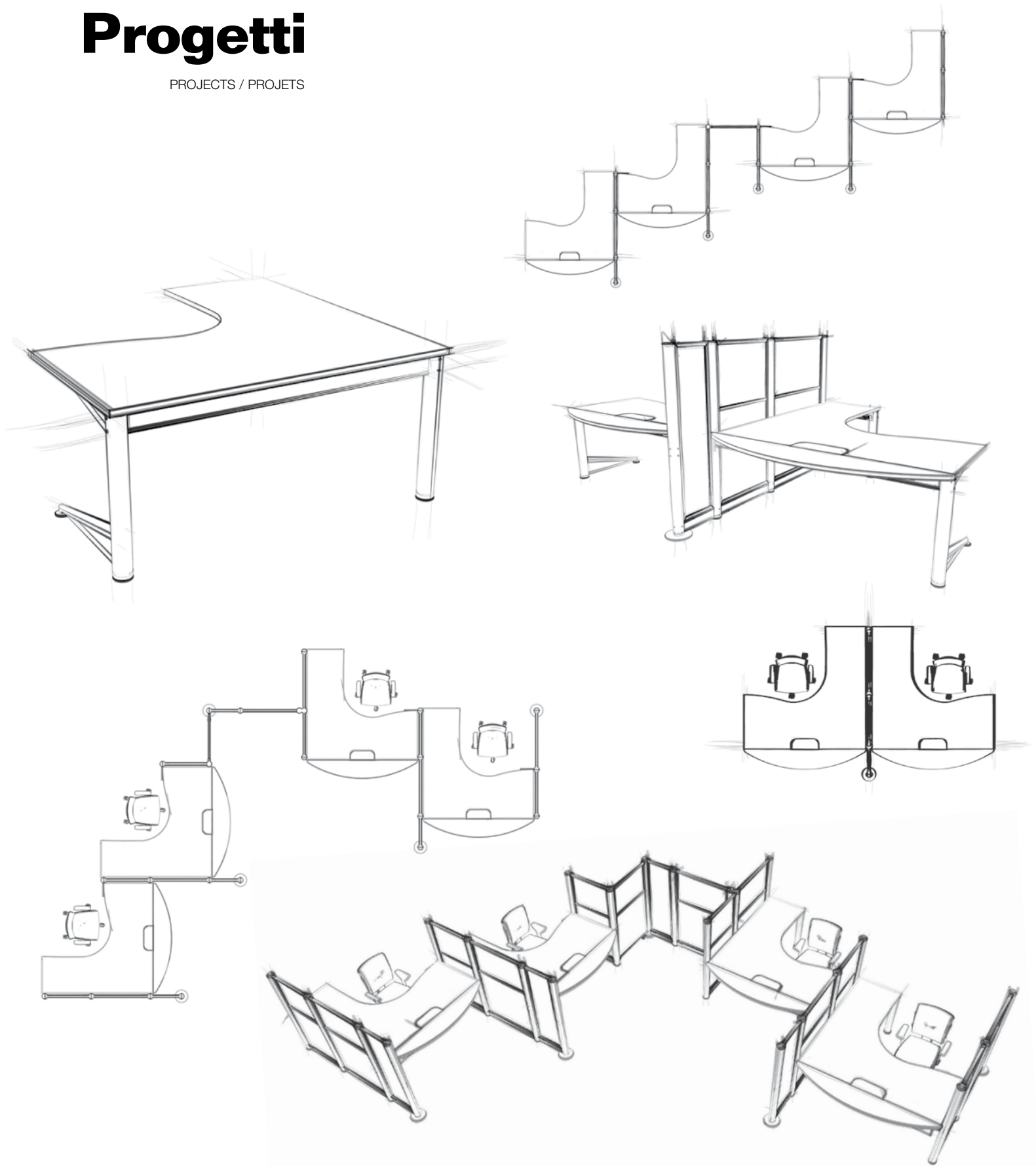

Pianta progetto - Plan project - Plante de projet

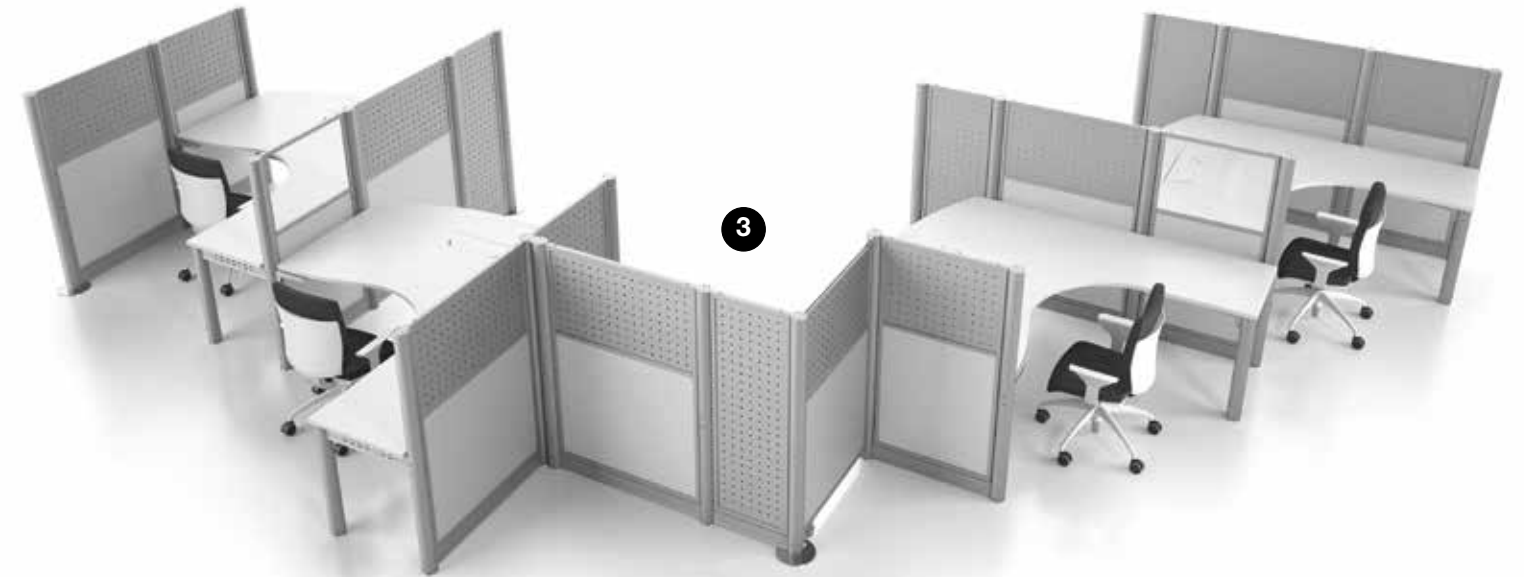
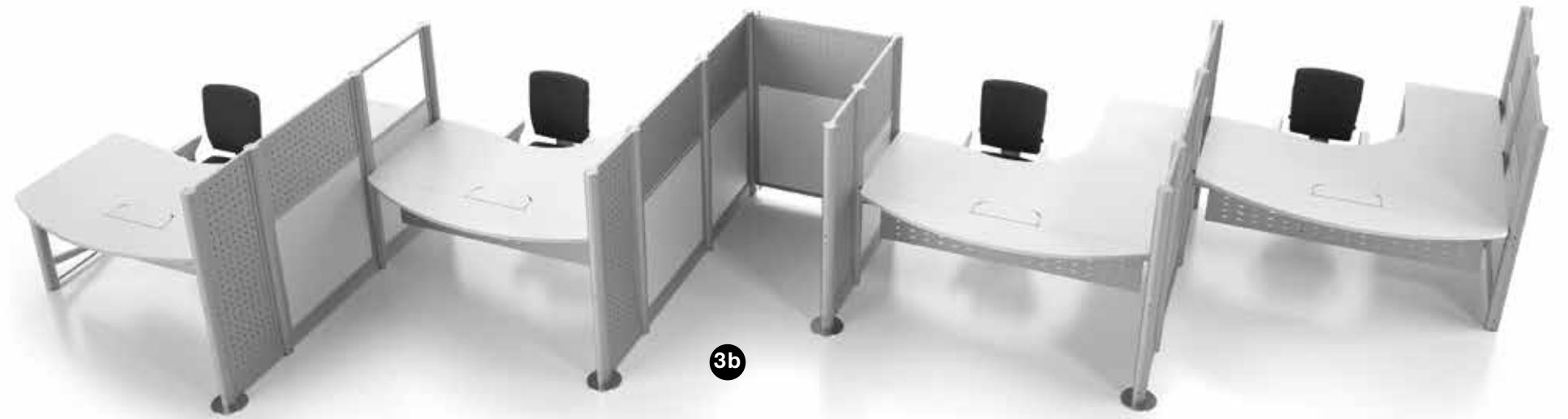





Arredamenti per l'Ufficio e la Collettività

mobilgraf s.r.l.

Sede e Show Room

Via Po, 43/b – 00198 Roma

Tel. / Fax 06 85354384 r.a.

www.mobilgraf.it – info@mobilgraf.it